



# JP-88ty

Polyphonic Software Synthesizer

## INTRODUCTION

JP-88ty is a polyphonic Software Synthesizer emulating the JP-8080 Hardware Synthesizer. It combines the specific sound of this synth, virtual analog architecture and a graphical user interface that provides great usability. This guide will show you how to use the JP-88ty. There are some major feature differences between the Hardware Synth and the JP-88ty Plugin.

**Added features:** 3-band parametric Equalizer with output gain, Chorus FX, Stereo Delay FX, Start Delay for both LFOs and panorama routing for each oscillator through the filter section.

## PURCHASE AND AUTHORIZATION

After purchasing the plugin, you need to send your "User ID" to the e-mail address below. You can look up your "User ID" inside the "Authorization" screen in the Plugin Menu

Please send this "User-ID" to me at: [license@icewolfaudio.com](mailto:license@icewolfaudio.com) (in case the mail-address is not working, please get in touch with me on my social media). Your personal User-ID is needed to generate your serial number.

You purchase the option of 3 serial numbers in total. If at some point your system hard drive needs to be changed or swapped, you will need a new serial number to reactivate the Plugin.

### Activation

To activate the software, load up the plugin inside your DAW. Then follow the steps below.

- Open the "**Authorization**" menu
- Enter your **serial number** in the appropriate input field.
- Press the button "**SAVE LICENSE FILE**" (a „license.reg“ file will be saved into your plugin folder)

The **serial number** is only usable for the **JP-88ty** on your specific system. If you change your system hard drive at some point, you have to request a serial number again. A new activation process can be made.

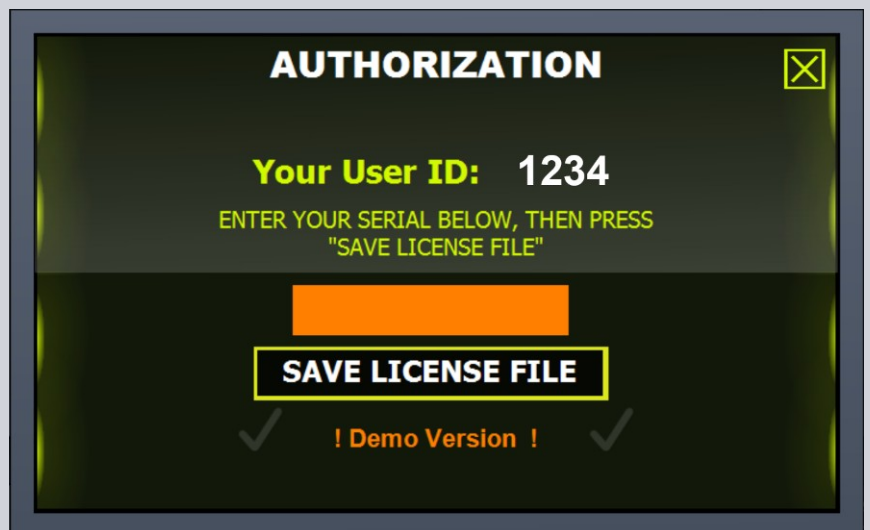
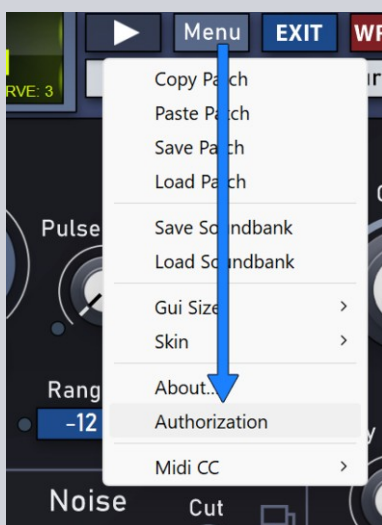

## Usage tips

Use shift + mouse left click on a knob / slider to fine adjust values.

Use mouse double left click, or Ctrl left click on a knob / slider to set default position.

## LED VU METER

The VU Meter in the upper right corner of the GUI shows the level of an outgoing audio signal. Range is -48 dB to 0 dB. at middle position the signal is around -24 dB.

### Midi All Notes Off

The VU Meter has another function as well. If there is a Midi Note hanging at some point (endlessly playing a sound), just left click the VU Meter and an "All Notes Off" – Message will be send to the synth engine immediatly.

This will stop any hanging midi notes

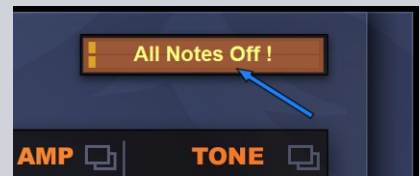
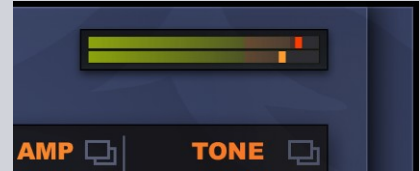

## TOP MENUS



Almost all buttons and menus in the top menu are explained in the individual sections of the user manual. But all buttons and menus that have global functions and are not mentioned in the individual sections of the manual can be found here.

### Part

This menu has two options to choose from. It can be used to copy all settings and values from one Layer to the other Layer. Copying all settings from Lower to Upper or vis versa. Use this with care. The copy process has no undo option.

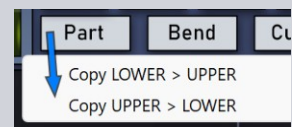

### Bend

In this menu the amount of pitch bend range is set. Using a Pitch Bend control with the JP-88ty will bend the pitch of the sound for both Layers in the range of the setting made in this menu.

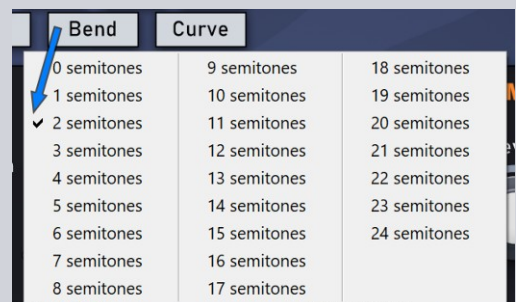

### Curve

Fixed Amount or a type of exponential curve conversion is set for incoming **Velocity** values. Values range from 0-127 is not changed if Fixed Amount is selected. But they will be changed if one of the Curves is selected.

**Curve 1 to 4** sets a conversion formula to the incoming values of velocity. values along an exponential curve. **Curve 1** is a slightly exponential conversion and **Curve 4** is a very strong conversion.

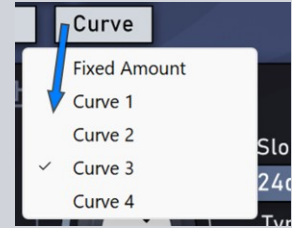

## PRESET MANAGEMENT

The JP-88ty has a secure preset management. After editing any value you need to **WRITE** or **Copy/Paste** the preset. Your changes are lost, if you don't write or paste the preset. This prevents accidentally changing a sound. Either change values of a sound and **WRITE** the preset in place if you want to keep it, or **Copy/Paste** the sound to another preset. Changing a preset forth and back, will recall the original preset. The JP-88ty can load 1 soundbank with 100 presets.

### Select Presets

Managing presets is very easy in the JP-88ty. Either click on the **preset name** in the display, or the **LIST** button to open the preset list. Click the **Left** and **Right Arrow** buttons beside the display to select the previous or next preset. Press **ESC** or mouse left-click somewhere to close the list.

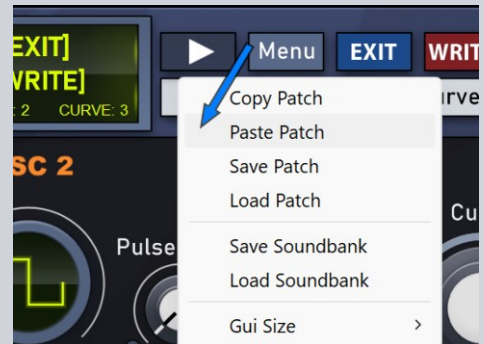
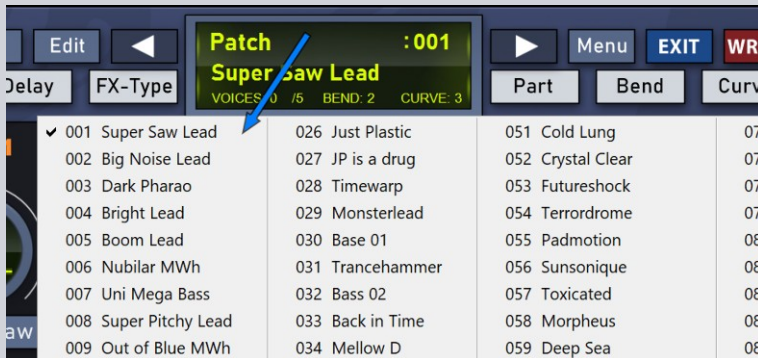

### Rename Presets

To rename a preset, click on the **EDIT** button left of the name display. Change the name with your keyboard and press either enter, or click somewhere if you want to finish editing.

### Copy, Paste, Save, Load

To copy, paste, save or load presets and/or soundbanks, click on **MENU** and select the appropriate menu item.

### Init Presets

Click the **Init** button to open the initialization quick menu. Click **Init Patch** to set all controls of the actual preset to default values. Click **Init All Patches!** to set all controls of all patches in the actual soundbank to their default values.

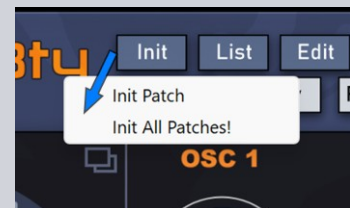

### Write Presets

To write a preset click the **WRITE** button right of the name display. Click the **WRITE** button once again to save the preset in place, or press **EXIT** to cancel the write operation.



### MIDI LEARN

The JP-88ty has a Midi-Learn feature for all controls with a LED-dot next to it. Any of these controls can receive a Midi control change number to control it via an assigned Midi-CC number.

#### Learn or Remove Midi CC

Right click with the mouse on the control to open the Midi-Learn quick menu. Left click „Midi Learn“ to set the control into „Learn“ mode. Now move the control on your hardware midi controller to send Midi data to the plugin and the CC number will be detected and stored for this control. The lit LED next to the control indicates that a Midi CC has been learned. Hover over the control shows the actual CC number in the name display, instead of the preset number. Click the "Rem" button to remove all learned Midi CC assignments.



### Save/Load Midi CC Configuration

Click on the "Menu" to open the main menu. Hover over the "Midi CC" item.

Click "Save Midi CC config" to save all actual Midi CC assignments in a config file.

Click "Load Midi CC config" to load a Midi CC assignment config file.

The Midi CC Configuration assignments are used globally for all presets and Instances of the plugin.

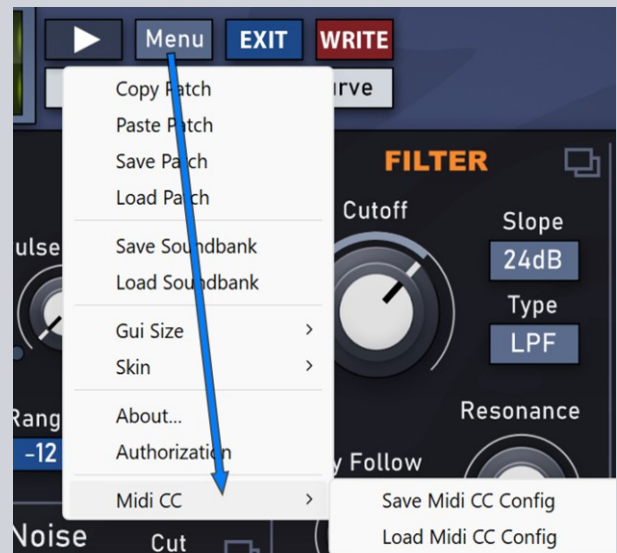

## GUI SIZE

The Gui of the plugin is designed to be very 8k-friendly. The graphical background and vector elements are designed for high resolutions and displays with 40+ inches in size. The Gui can be resized from 50% up to 400% of it's default size.

Click the Icewolf icon on the left top, or right click the lower right corner of the gui to set a gui-size. You can also left click this lower right corner and drag it to freely resize the plugin to your liking.

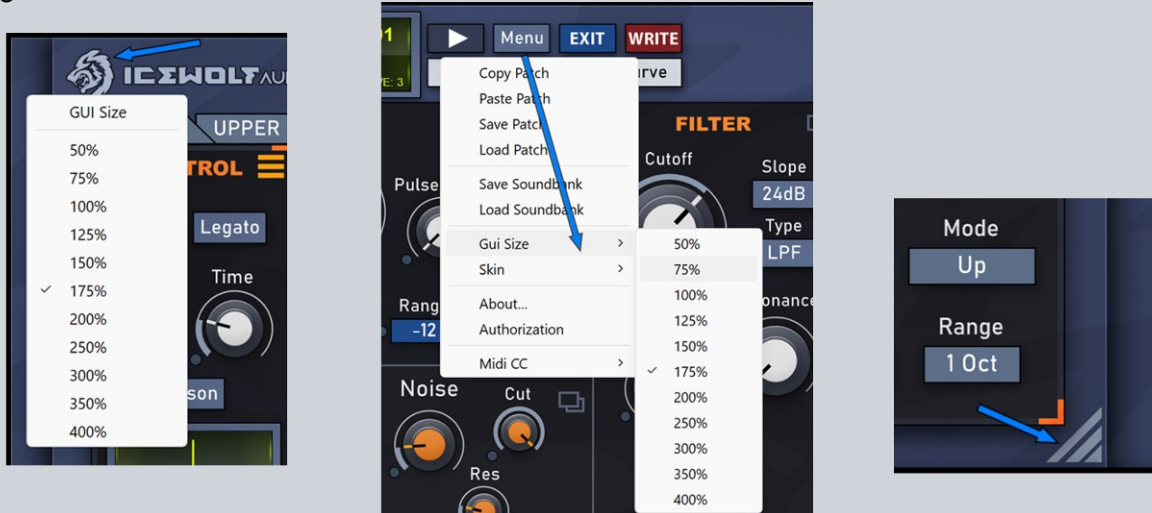

## GUI SKINS

The JP-88ty comes with different Skins you can change to via the main menu. These are default skins and the selected skin is stored in the settings.cfg for every instance of the plugin.

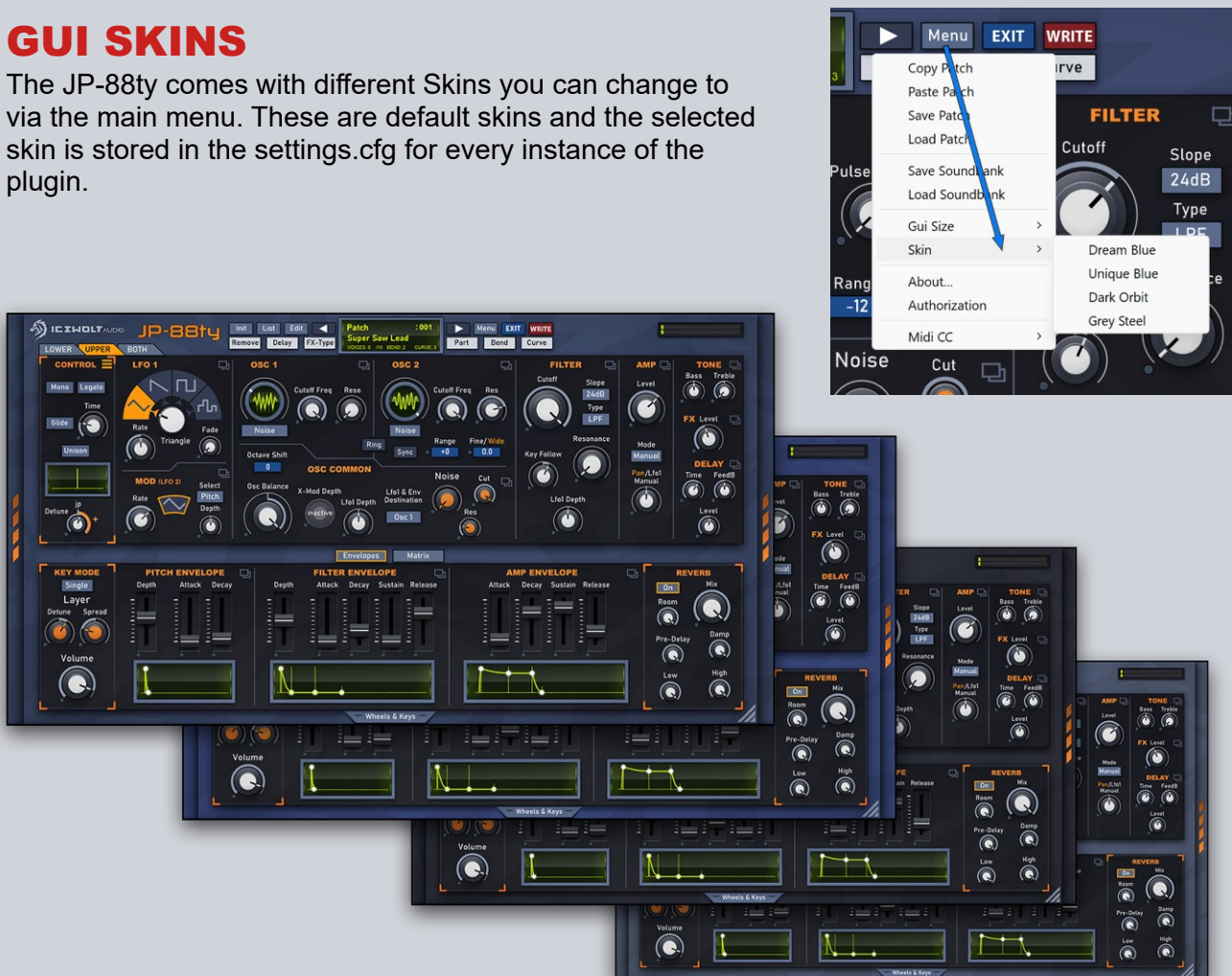

## WHEELS & KEYS

The synthesizer UI has an extension panel with Modulation wheels and a five-octave keyboard. The wheels and keyboard show incoming values of corresponding data and are also real inputs for the synth. Not every hardware controller has all of these input controls built in, but with the help of this extension their input can be emulated with a mouse.

Breath or Aftertouch controls are usually not "wheels" on a controller, but a moving wheel is great to see incoming data or to use it as an input for the synth. **Pitch Bend, Modulation Wheel, Breath Control** and **Aftertouch** are shown and used via the 4 modulation wheels.

The Midi Keyboard Keys can be used to simulate note input via mouse clicks.



The button to show or hide the gui extension is located at the bottom of the user interface.

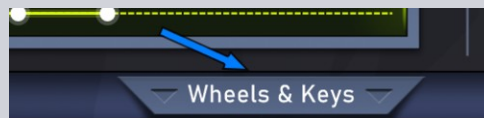

The setting of show/hide is stored in the settings.cfg. The synth does remember the last state.



The JP-88ty with expanded Wheels & Keys...

## CONTROL

In this section are the global settings of a preset.

### Mono / Legato

The **Mono** button switches the synth into monophonic mode. Only one note at any time will sound (1 Voice). Every new note will trigger the envelopes. The **Legato** button switches the synth also into monophonic mode, but if notes are played in legato (hold down last note), the sound will glide to the next note pitch, without triggering the envelopes again.

### Glide

Click the **Glide** button to turn the Glide function on or off. When activated, the pitch of a played note changes smoothly over time to the newly played note. The duration of the transition can be set with the **Time** button.

### Unison

This button switches the synth into it's unique unison mode. Unison is a monophonic playmode. In the Key Mode **Single** the synth generates 10 detuned voices of the sound. In **Dual** Mode it generates 5 detuned voices. The sound ist thickened up and sounds unique.

### Detune

Turn this control to increase / decrease the unison detune amount. This control has a higher amount than the value in the jp-8080. At the mark "jp" it sounds like the maximum amount of detune of the jp-8080. The "+ Range" is the boost amount to detune unison voices beyond this value.



## CONTROL Menu

### Polyphony

This sets the maximum Voices of the JP-88ty. 10 is the standard setting but the synth can be set to 16 voices max. In **Dual** Mode this amount ist shared to both Layer. The more voices are set, the more CPU-Power the synth uses.

### Chorus Sync

Set the Sync of the Chorus to **FX-Type** or **Lfo1**. If FX-Type is selected, every Chorus FX will have its pre-defined Rate setting. If Lfo1 is selected, the rate of Lfo1 is the FX-Type Rate.

### Lfo1 Sync

Lfo1 has two options here. Sync the rate to **Host BPM** or **Manual**.

### Delay Sync

The Delay has also two options here. Sync the time of the Delay to **Host BPM** or **Manual** rate.

### Mod CC X and Y

Set the Mod **CC X** and **Y** control numbers here. The Midi **CC X** and **CC Y** control numbers are used as sources in the **Mod Matrix**. The range is 1-127.

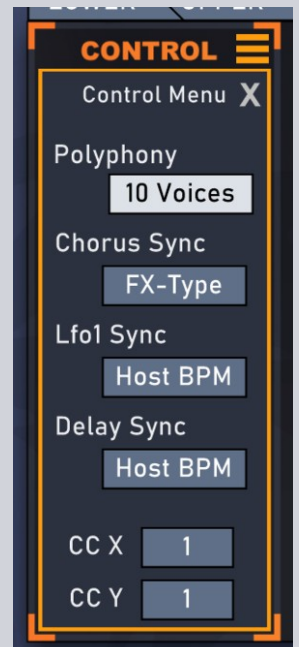



# OSCILLATORS



Oscillators are the heart of a synthesizer. They produce the sound. The JP-88ty has 2 oscillators per Layer. Each oscillator has some different features. The behavior of the oscillators is modeled after the ones from the hardware synth. Select the waveforms which will be the basis of the sound. The sound that you specify here is the basis of the sound that you create.

## OSCILLATOR 1

Oscillator 1 delivers a periodic oscillation where you can determine waveshape and frequency. The frequency is defined by the pitch of the notes that are sent via MIDI. The waveforms you can select are:

Super Saw, TriMod, Noise, Feedback Osc, Square, Saw, Triangle



### WAVEFORM

Click and drag the Waveform Display to select one of the available waveshapes. You can also press the button under the waveform display to select a waveform from a drop-down list.

**Control 1 / Control 2** modify parameters unique to that waveform. The labels of these controls change corresponding to the selected waveform. In the following explanation, **Control 1** will be listed as **1**, and **Control 2** as **2**.

### SUPER SAW

This sounds like seven sawtooth waveforms sounding simultaneously. Pitch-shifted sounds are added to a central Sawtooth wave. It is especially suitable for creating thick string-type sounds, and allows you to produce a thick sound even when the Key Mode is Single.

#### 1 Detune

Adjust the degree of pitch detuning. As the knob is rotated to the right, the pitch will be detuned more greatly, making the sound more spacious.

#### 2 Mix

Adjust the volume of the detuned sounds relative to the central sound. As the knob is rotated to the right, the detuned sounds will become louder, making the sound thicker.

Changes in Detune ->



### Changes in Volumes ->



## TRIANGLE MOD

This is a modification of a triangle waveform, with a large number of overtones. Since there is much energy in the overtones and little in the fundamental, the result is similar to applying an High Pass Filter to a square wave.

### 1 Offset

Specify the way in which the triangle wave will be shaped. As the knob is rotated to the right, the waveform will be modified more significantly, producing a greater proportion of overtones.

### Changes in Offset ->



### 2 Lfo1 Depth

Adjust the amount of effect which Lfo1 will have when it is applied to Offset. As the knob is rotated to the right, Offset will change more.

## NOISE

The Noise Osc produces a "white noise sound". A resonant Low Pass Filter is applied to the noise. Many different "colors" of noise can be produced.

### 1 Cutoff Freq

Here you set the cutoff frequency of the LPF. Turn the control left to cut off high frequency components of the noise. At the same time the volume of noise increases. Since the cutoff frequency will change depending on the key that you play, the sound will change. The cutoff frequency will rise as you play higher notes, and will fall as you play lower notes.

### 2 Reso

This regulates the emphasis that is applied to the region at the cutoff frequency. As the knob is rotated to the right, the sound will have a greater sense of pitch. If the knob is rotated to the right all the way, a sine wave will result.

### Changes in Cutoff Frequency ->

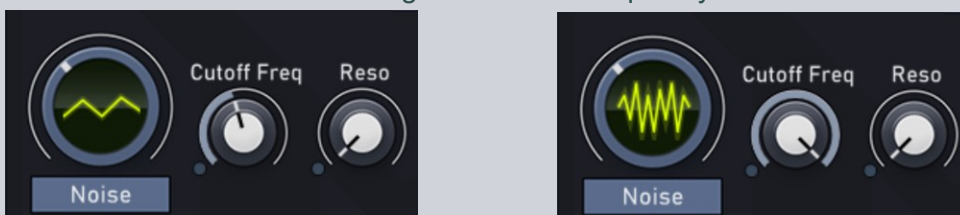

### Changes in Resonance ->

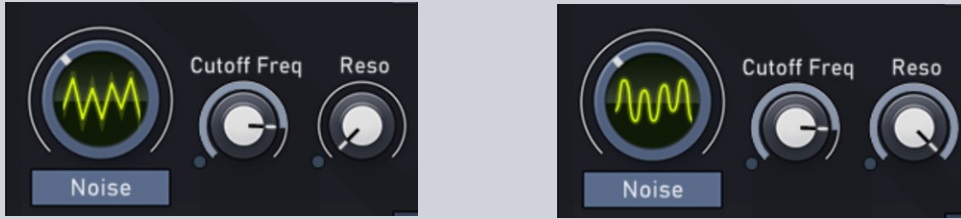

## FEEDBACK OSC

This sound is similar to electric guitar feedback. It is suitable for creating hard and aggressive sounds that stand out. The Feedback Oscillator playing modes in the JP-88ty are different to the limitations of the JP-8080. The Feedback Osc can be played in **polyphonically** and the **Unison** is available for this Oscillator too.

### 1 Harmonics

Vary the sound of the harmonics.

### 2 Feedback

Adjust the amount of feedback to adjust the level of the aggressiv sounding harmonics.

## SQUARE

This sound is similar to a woodwind instrument. It also widely used in making typical “synthesizer” sounds.

### 1 Pulse Width

Set the width of the square wave with this control. Higher values produce more overtones and make the sound thinner.

### 2 Depth

The technique of applying Lfo1 to the Pulse Width is Pulse Width Modulation (PWM). Depth determines how much Lfo1 will affect the Pulse Width. Increasing the value creates a broader and richer Square sound.

### Changes in Pulse Width ->

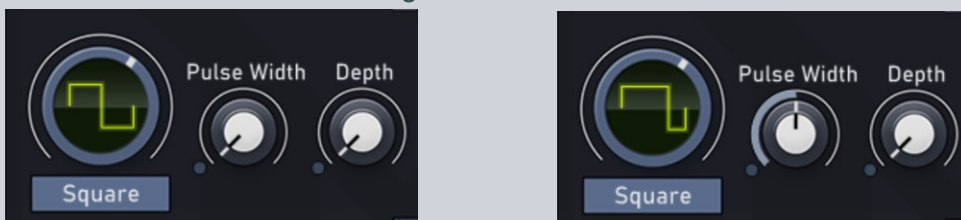

## SAWTOOTH

This waveform is used for nearly all instruments except for woodwind sounds. Many sounds unique to synthesizers can be created using this waveform.

### 1 Shape

Specify the degree to which the sawtooth wave will be modified. The sound can have a strong fundamental. Suitable for thick more bassy sounds. Increasing the control makes the sound more thin, like applying a High Pass Filter

### 2 Lfo1 Depth

When LFO1 is applied, this parameter specifies how greatly the shape will be modified by Lfo1. Increasing the value creates a contineously chaning waveform sound.

Changes in Shape ->



## TRIANGLE

This is a simple sound with few overtones. It is used for creating flute or smooth sounds.

### Shape

Specify the degree to which the triangle wave will be modified. Increasing the value results in more overtones. It sounds similar to a square wave with a Low Pass Filter applied.

### 2 Lfo1 Depth

When LFO1 is applied, this parameter specifies how greatly the shape will be modified by Lfo1. Increasing the value creates a continuously changing waveform sound.

Changes in Shape ->



## OSCILLATOR 2

In the same way as for the Osc1 section, this selects the waveform that will be the basis of the sound. By combining Osc1 and Osc2, a variety of sounds can be created. The waveforms you can select are:

**Square, Saw, Triangle, Noise**

### Waveform Ring

Click and drag to select one of the available waveshapes.

**Control 1 / Control 2** modify parameters unique to that waveform. Only when **Square** or **Noise** are selected, these controls will modify parameters unique to these waveforms. The labels of these controls change corresponding to the selected waveform. In the following explanation, **Control 1** will be listed as **1**, and **Control 2** as **2**.



## SQUARE

This sound is similar to a woodwind instrument. It also widely used in making typical “synthesizer” sounds.

### 1 Pulse Width

Set the width of the square wave with this control. Higher values produce more overtones and make the sound thinner.

### 2 Depth

The technique of applying Lfo1 to the Pulse Width is Pulse Width Modulation (PWM). Depth determines how much Lfo1 will affect the Pulse Width. Increasing the value creates a broader and richer Square sound.

Changes in Pulse Width ->

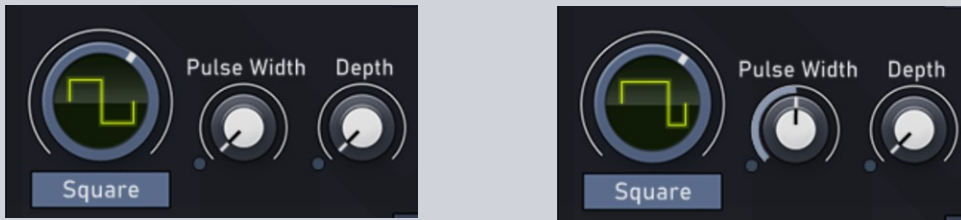

## SAWTOOTH

This waveform is used for nearly all instruments except for woodwind sounds. Many sounds unique to synthesizers can be created using this waveform.

## TRIANGLE

This is a simple sound with few overtones. It is used for creating flute or smooth sounds.

## NOISE

The Noise Osc produces a "white noise sound". A resonant Low Pass Filter is applied to the noise. Many different “colors” of noise can be produced.

### 1 Cutoff Freq

Here you set the cutoff frequency of the LPF. Turn the control left to cut off high frequency components of the noise. At the same time the volume of noise increases. Since the cutoff frequency will change depending on the key that you play, the sound will change. The cutoff frequency will rise as you play higher notes, and will fall as you play lower notes.

### 2 Reso

This regulates the emphasis that is applied to the region at the cutoff frequency. As the knob is rotated to the right, the sound will have a greater sense of pitch. If the knob is rotated to the right all the way, a sine wave will result.

Changes in Cutoff Frequency ->

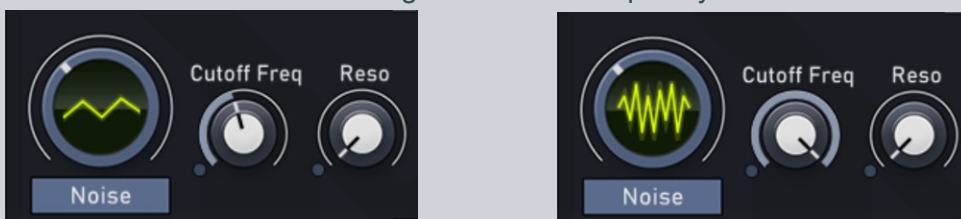

## Changes in Resonance -&gt;

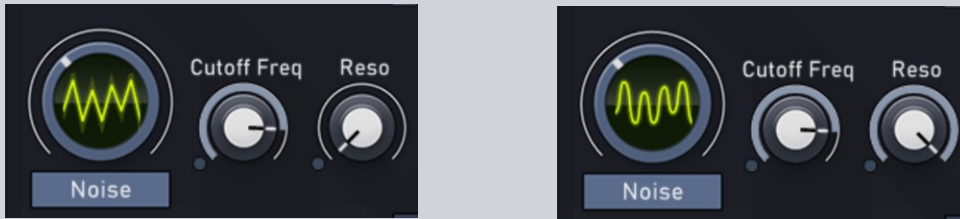
**SYNC (Sync Switch)**

This button switches sync on/off. When this is on, the indicator will light, and a complex sound with many overtones will be produced. Sync is most effective when the Osc2 pitch is higher than the Osc1 pitch. Sync causes the output waveform of Osc2 to be synchronized to the output waveform of Osc1. ("Functions using Osc1 and Osc2". I.e., each time the Osc1 waveform returns to the beginning of its period, Osc2 will also be forcibly reset to the beginning of its period, producing a complex waveform.

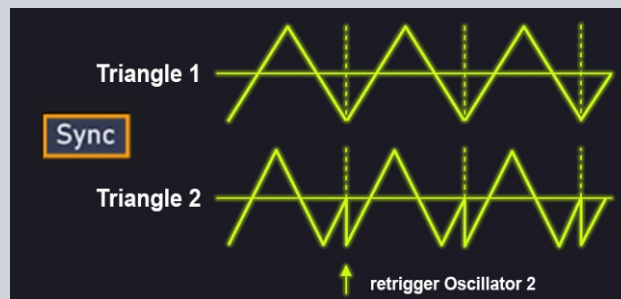

If the effect of **Sync** is hard to hear, turn **Osc Balance** towards the right (Osc2). Sync will not work if **Noise** is selected as the Osc2.

**Using Sync (Hint)**

If you turn on **Sync** and modify **Range** or **Fine/Wide**, the sound of Osc2 will change in various ways while the pitch remains the same.

**RANGE**

Specify the pitch of Osc2 in relation to Osc1 over a range of +/-24 semitones (+/-2 octaves). Set Range to 0 to have the same pitch as Osc1. With settings of -WIDE or +WIDE, the **Fine/Wide** knob can adjust the pitch of Osc2 over a +/-4 octave range. However in this case, you must be sure to rotate the knob fully right or left. To make accurate settings, the -24, -12, 0, +12 and +24 settings have a greater width than other settings.

**FINE/WIDE (Fine Tune)**

When the **Range** setting is within -24 or +24, this control provides a +/-50 cent (+/- 1/2 semitone) adjustment to the pitch specified by the **Range** setting. Turning the control increases or decreases the pitch of Osc2.

When the Range control is in the fully left **-WIDE** or fully right **+WIDE** position, this control changes the pitch seamlessly between -4 and +4 octaves.

**Giving the sound more space (Hint)**

If you select the same waveform for Osc1 and Osc2, use **Fine/Wide** to create a slight difference in pitch, the sound will appear more spacious (detune effect).

## RING (Ring Modulation Switch)

This turns Ring Modulation On or Off. When activated, the sound will become more metallic. This is suitable for creating bell sounds. The ring modulator multiplies the Osc1 waveform with the Osc2 waveform, producing a sound that contains many overtones not found in either of the original waveforms. The resulting sound is very dissonant and feels un-pitched.

The sound with the generated overtones will be generated by Osc2. If the effect of **Ring** is hard to hear, turn **Osc Balance** towards the right (Osc2).

## OSC COMMON



In this section and the Pitch Envelope section, you can make settings affecting both Oscillators. An additional Noise Osc is also available (the orange controls to the right).

## OSC BALANCE

This adjusts the balance between **Osc1** and **Osc2**. In center position both oscillators will have the same volume. Decrease the value from there makes Osc1 louder. Increasing the value will make Osc2 louder.

## OCTAVE SHIFT

Shift the pitch that is produced when you play your MIDI, in octave steps. It is convenient to use this method when you wish to change just the Patch of a specific Part in Dual mode.

Press and hold the value field and drag it up or down with the mouse to change the octave pitch between -2 to +2 octaves.

## X-MOD DEPTH (Cross Modulation Depth)

Cross Modulation modifies **Osc1** with the frequency of **Osc2**. The control adjusts the depth of this Cross Modulation. Increasing the value will produce a more complex sound of Osc1. More overtones and harsh waveform distortion will occur. This is a great control to create metallic sounds and sound effects.

If Osc1 waveform is set to **Super Saw** or **Noise**, the Cross Modulation effect can not be obtained. If the Cross Modulation effect is difficult to hear, turn **Osc Balance** left towards Osc1 position.

## Tonal changes using Cross Modulation

Leave **X-MOD Depth** raised, and move **Osc2 Range** or **Fine/Wide** to modify the tone in various ways without changing the pitch.

## LFO 1 & ENV DESTINATION

Select one of the following three possibilities to specify how **Lfo1** and the **Pitch Envelope** will be applied.

- Osc 1+2: Lfo1 and the envelope will be applied to the pitch of Osc1 and Osc2
- Osc 2: Lfo1 and the envelope will be applied to the pitch of Osc2
- X-Mod: Lfo1 and the envelope will be applied to Cross Modulation Depth.

## LFO 1 DEPTH

Specify the depth for when Lfo1 is applied to the pitch. As the knob is rotated from the center position toward the right, the change will become greater. As it is rotated from the center toward the left, the Lfo1 waveform will be inverted, and change will become greater in the opposite direction. When the knob is in the center position, Lfo1 will not affect the pitch.

If **X-MOD** is selected for **Lfo1 & ENV Destination**, read “pitch” in the above explanation as “**cross modulation depth**”.

## NOISE OSC

The additional **Noise Osc** produces a "white noise sound". A resonant Low Pass Filter is applied to the noise. Many different “colors” of noise can be produced.

## CUT (Cutoff Frequency)

Here you set the cutoff frequency of the LPF. Turn the control left to cut off high frequency components of the noise. At the same time the volume of noise increases. Since the cutoff frequency will change depending on the key that you play, the sound will change. The cutoff frequency will rise as you play higher notes, and will fall as you play lower notes.

## RES (Resonance)

This regulates the emphasis that is applied to the region at the cutoff frequency. As the knob is turned to the right, the sound will have a greater sense of pitch. If the knob is turned to the right all the way, a sine waveform will result.

## PITCH ENVELOPE

If **X-Mod** is selected for **Lfo1 & ENV Destination**, read “pitch” in the following explanation as “**cross modulation depth**”.

### DEPTH

Specify the depth of the pitch envelope. Raising the slider above the center position will produce a greater change. Lowering the slider below the center position will invert the shape of the envelope, and produce an increasing amount of change in the opposite direction. When the slider is in the center position, the pitch envelope will not affect the pitch.

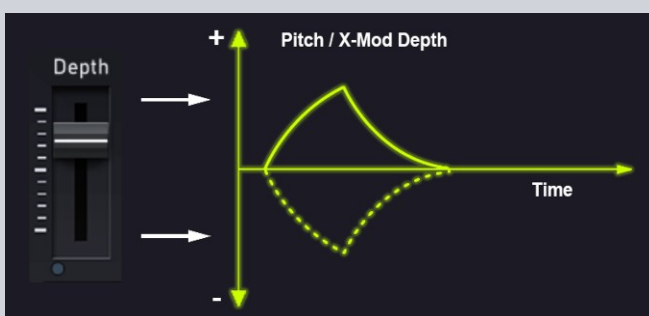



When applying a positive (+) envelope to **X-Mod**, the effect will be stronger if **X-Mod Depth** is set to a low value. When applying a negative (-) envelope, the effect will be stronger if **X-Mod Depth** is set to a high value.

### ATTACK / DECAY

Set the **Attack** and **Decay** time of the pitch envelope. The value will increase as the slider is raised.

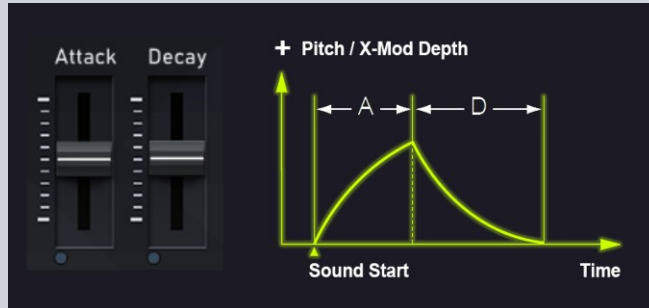

**Attack:** Time from sound start until the maximum pitch change is reached.

**Decay:** Time from maximum pitch change reaches the normal pitch again.

### Overview Routings Osc1 and Osc2

Functions using Osc1 and Osc2 (Sync, Ring Modulator, Cross Modulation) are applied and switched as shown in the following diagram.

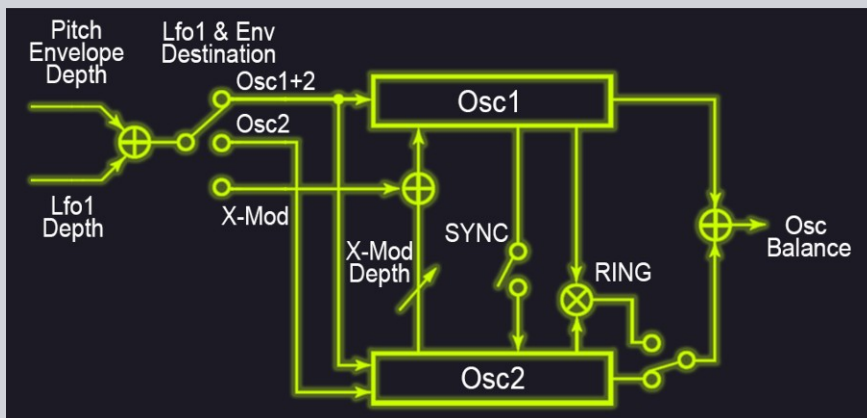

## FILTER

The filter allows a specific range of frequencies to pass (or restricts the way that they pass). This modifies the brightness of the sound. The **Filter** section and the **Filter Envelope** allow you to select the Type of this filter. The output waveform can be changed in different ways to modify the brightness of a sound.

### TYPE (Filter Type)

Select one of the following three filter types.

#### HPF (High Pass Filter)

This type of filter allows partials higher than the cutoff frequency to pass. This is useful when you want the sound to be bright and sharp.



### **BPF (Band Pass Filter)**

This type of filter allows partials in the region of the cutoff frequency to pass. This will result in a stronger the mid-range sound.

### **LPF (Low Pass Filter)**

The LPF allows partials lower than the cutoff frequency to pass. This is the most common type of filter, and is useful when you want to make the sound more mellow and less bright.

### **SLOPE (-12dB/-24dB)**

The slope of the filter falloff. You can choose between -12 dB/oct or -24 dB/oct. The slope changes the steepness of the falloff at cutoff frequency. The slope at -24 dB/oct sounds more "pitchy" on the resonance value than the -12 dB/oct

### **CUTOFF (Cutoff Frequency)**

This sets the cutoff frequency of the filter. Cutoff frequency is the parameter which specifies the frequency at which the filter will begin restricting (cutting off) parts of the frequencies. Modifying the cutoff frequency controls the brightness of the sound. As the value is raised, the cutoff frequency will become higher, producing a brighter tone.

### **RESONANCE**

As Resonance is raised, the frequencies around the region of the cutoff frequency will be emphasized, producing a distinctive sound. Very high values or Resonance will result in a new sound in addition to the sound of Osc1 and Osc2. This resonant sound is known as self oscillation.

### **KEY FOLLOW**

This sets the Key Follow depth for the filter. When the filter is a LPF, a central setting of Key Follow will cause the cutoff frequency to remain the same on every note. If higher notes are played, there will be fewer partials in the sound, making it increasingly more mellow in comparison to lower notes. As the control is turned toward the right, higher notes will have a correspondingly higher cutoff frequency (brighter sound). Turning the control towards the left means lower more mellow sound on higher notes and brighter sound on lower notes.

When **Cutoff Frequency** is set to the center position, the Key Follow effect will be clearly noticeable.

### **LFO1 DEPTH**

When Lfo1 is applied to cutoff frequency, this parameter determines the depth of the effect. As the control is turned to the right of center, the effect will increase. As the control is turned to the left of center, the Lfo1 waveform will be inverted, and the effect will increase. With a setting in the center position, Lfo1 will not affect the cutoff frequency (brightness).

## **FILTER ENVELOPE**

### **DEPTH (Envelope Depth)**

This adjusts the depth of the filter envelope. Raising the slider above the center position will increase the change.

As the slider is lowered below the center position, the change will increase in the opposite direction.

With a setting in the center position, the filter envelope will not affect the brightness.

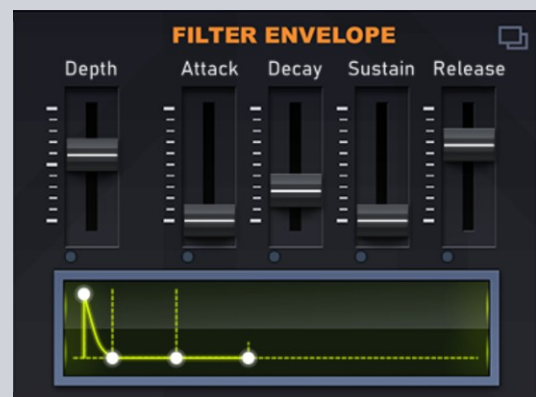

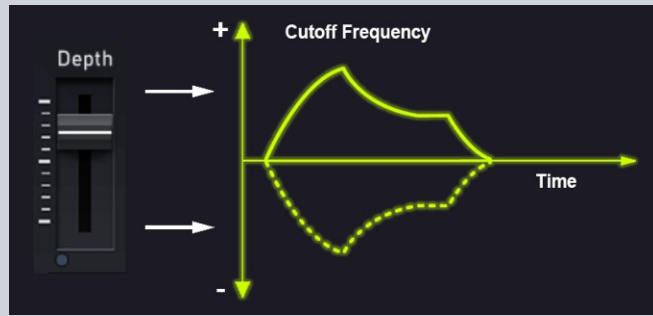

When applying a positive (+) envelope, the effect will be more apparent while **Cutoff Frequency** is set to a low setting. When applying a negative (-) envelope, the effect will be more apparent if **Cutoff Frequency** is set to a high setting.

### ATTACK / DECAY / SUSTAIN / RELEASE

These parameters set the Attack Time, Decay Time, Sustain Level and Release Time of the filter envelope. Raising a slider will increase the value in the envelope.

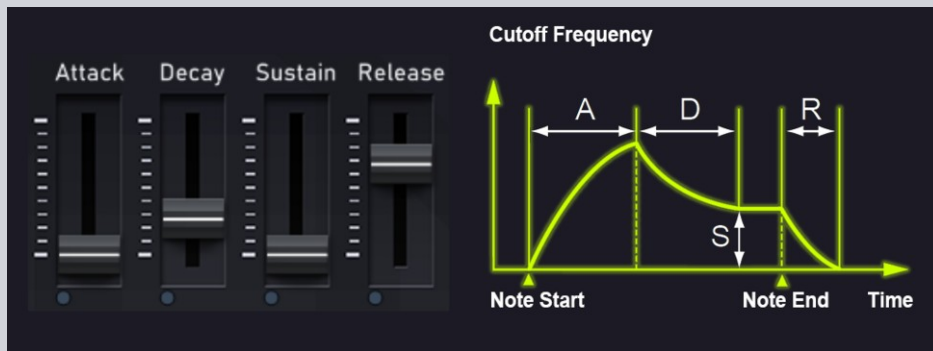

**Attack:** The time from when the note is played until the maximum brightness is reached

**Decay:** The time until the brightness reaches a steady level

**Sustain:** The level at which the brightness will remain steady

**Release:** The time from when the key is released until the sound returns to its original brightness

## AMP (Amplifier)

### LEVEL

Specify the volume of the Patch. The volume will increase as the control is turned towards the right. The Level setting is saved in the Patch, so if you want each Patch to have a different volume, you can set each Patch accordingly. In contrast, the **Volume Level** is used to adjust the volume of the JP-88ty globally

### PAN (Auto Pan/Manual Pan Switch)

Select one of three ways in which the volume or pan (stereo position) will change.

**Off:** Lfo1 will cyclically modulate the volume.

**Auto:** Lfo1 will cyclically shift the panning between left and right.

**Manual:** Turn the pan control to pan the sound left or right.

When **Mode** is **Off** or set to **Auto**, this parameter determines how greatly Lfo1 will be applied to Level or Pan.

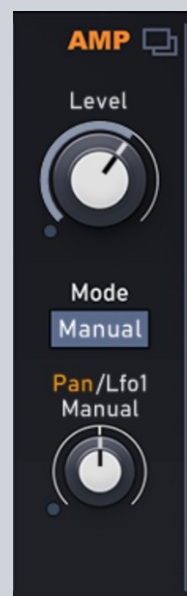

Turning the control towards the right of center will produce greater change. Turning the control towards the left of center will invert the Lfo1 waveform, and produce greater change in the opposite direction. In center position Lfo1 will not affect level or pan.

When **Mode** is set to **Manual**, turning the knob towards the right of center will pan the sound towards the right. Turning it towards the left of center will pan the sound toward the left. At center position the sound will sound from the center.

## AMP ENVELOPE

### ATTACK / DECAY / SUSTAIN / RELEASE

These parameters set the Attack Time, Decay Time, Sustain Level and Release Time of the amplifier envelope. Raising a slider will increase the value in the envelope.

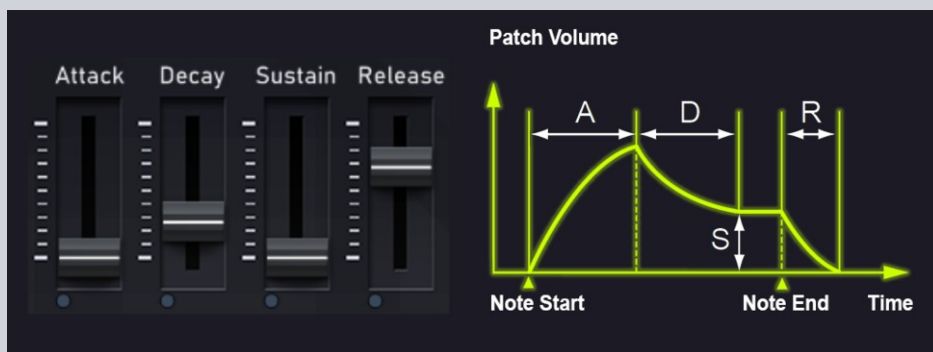

- Attack:** The time from when the note is played until the maximum volume is reached
- Decay:** The time until the volume reaches a steady level
- Sustain:** The level at which the volume will remain steady
- Release:** The time from when the key is released until the sound disappears

## LFO 1

The Lfo1 (Low Frequency Oscillator) section outputs a waveform, just as the Osc1 and Osc2 sections. The Lfo1 waveform is used to cyclically modulate the pitch, brightness, or volume of the sound.

**Lfo1 Depth** control of the **Osc Common** section, **Filter** and **Amp** section, sets the amount of these parameters.

### WAVEFORM

Select one of the following four waveforms as the Lfo1 output waveform. The sound will be modulated by the selected Lfo1 waveform.



### TRIANGLE WAVE

The sound will be modulated continuously. This waveform is suitable for vibrato effects.

## SAWTOOTH WAVE

When the sound reaches its minimum setting, it will then return to the maximum setting. Then it begins to fall again. If the **Lfo1 Depth** in the **Osc Common**, **Filter**, and **Amp** sections is turned to the left of center, the direction will be inverted.

## SQUARE WAVE

The sound will alternate between two settings.

## SAMPLE & HOLD

The sound will switch randomly between various settings.

## RATE

This sets the modulation speed for Lfo1. As the control is turned to the right, the modulation speed will increase. The **Lfo1 Rate** can be synchronized to the Host Tempo.

## FADE (Fade Time)

Specify the time from when you press the key and the Lfo1 begins to apply until the modulation reaches the amount specified by the Depth settings. Turning the control towards the right will increase the time until the full amount of modulation is reached.

## MODULATION (LFO 2)

You can use the modulation lever or wheel (Midi-CC #1) of a MIDI controller to apply modulation from **Lfo2** at a different frequency than **Lfo1**. Since the sound will be affected only when you move the modulation lever/wheel (Midi-CC #1). This is a useful way to add accents to a played sound. The Lfo2 waveform is fixed to a triangle wave. When the modulation lever is moved, the pitch, brightness, and volume will be modified simultaneously, each according to the Rate and the various Depth settings that you have made. **Lfo2** settings are made independently for each Patch.



## DEPTH SELECT

Select one of the following three options for which you will set the depth of modulation. The settings is stored internally and remains untouched if another option is selected.

**Pitch:** Set the depth of the Lfo2 effect on pitch. This produces vibrato.

**Filter:** Set the depth of the LFO 2 effect on the filter (brightness). This produces a wah effect.

**Amp:** Set the depth of the LFO 2 effect on the amplifier (volume). This produces tremolo.

## DEPTH

Turn **Depth** to set the depth of the Lfo2 effect on the currently selected Depth Select item (Pitch, Filter or Amp). Turning the control to the right of center will produce a greater effect. Turning the control to the left of center will invert the Lfo2 waveform and produce a greater effect. With a setting of center, Lfo2 will not affect the sound.

## RATE

Turn **Rate** to set the speed of modulation for Lfo2. Turn the knob toward the right will produce faster modulation. The Rate setting is common to Pitch, Filter or Amp. The Rate is set for all three options.

## TONE - FX - DELAY

Adjusting the High and Low Tone. The **Tone Control** lets you emphasize or attenuate the low or high frequencies of the sound to adjust the tone to your liking.

### BASS

This control increases / decreases the low frequency range. Turning the control towards the right of center will emphasize the low frequency range, producing a more bassy sound. Turning it towards the left of center will attenuate the low frequency range.

### TREBLE

This control increases / decreases the high frequency range. Turning the control towards the right of center will emphasize the high frequency range, producing a higher sound character. Turning it towards the left of center will attenuate the high frequency range.

Adding Spaciousness and Depth to the Sound Multi Effects Level is a function to do so. You can also select the type of multi effects via the **FX-Type Menu**.

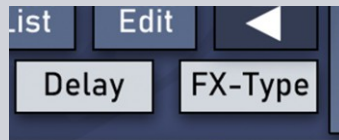

### FX LEVEL

Specify the amount of the multi effects. As the control is turned towards the right the effect will be applied more heavily.

The type of multi effects can be changed as appropriate for the sound you need. The JP-88ty provides 13 types of multi effects.

<b>Super Chorus Slow:</b>	Slow chorus with deep modulation.
<b>Super Chorus Mid:</b>	Chorus with medium modulation.
<b>Super Chorus Fast:</b>	Fast chorus with shallow modulation.
<b>Super Chorus CLR:</b>	Chorus with a transparent feeling.
<b>Flanger Slow:</b>	Flanger with delayed modulation.
<b>Flanger Deep:</b>	Flanger with deep modulation.
<b>Flanger Fast:</b>	Flanger with fast modulation.
<b>Deep Phasing Slow:</b>	Slow phasing with deep modulation.
<b>Jet Phasing:</b>	An effect reminiscent of a jet airplane taking off and landing.
<b>Twisting:</b>	An effect as though the sound were being twisted.
<b>Freeze Phase 1/2:</b>	A short delay. This is effective in adding a metallic resonance.
<b>Distortion:</b>	This effect distorts the sound.

The chorus Rate (speed of modulation) can be synchronized to MIDI Clock messages. For details refer to the **Control Menu**.

## DELAY

Delay is an effect that adds echoes to the sound. The settings of the Delay section affect how the delay sound is heard. You can also select the type of delay in the **Delay Menu**.

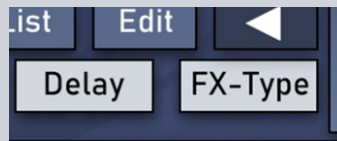

## LEVEL

Specify the amount of the delay sound relative to the original sound. As the control is turned towards the right, the delay sound will become louder.

## TIME

Specify the time from when a note is pressed to play a sound until when the delayed sound is heard. As the control is turned towards the right, the time will become longer.

It is also possible to synchronize the Delay Time to the Host Tempo. For details refer to the **Control Menu**.

## FEEDBACK

Specify the amount of feedback for the delayed sound, the way in which the delayed sounds will gradually diminish over time. With small amounts of feedback, the delayed sounds will diminish quickly after you release the key. As the control is turned towards the right, the feedback will increase, and the delayed sounds will diminish over a longer interval after you release the note.

The type of delay can be changed as appropriate for the sound you want. The JP-88ty provides 5 types of delay.

- Panning L->R:** The delayed sound is assigned to left and right in the order of left -> right.
- Panning R->L:** The delayed sound is assigned to left and right in the order of right -> left.
- Panning Short:** The delayed sound is assigned to left and right in the order of right -> left. The delay time is 1/4 of Panning L->R/R->L.
- Mono Short:** The delayed sound is assigned to the center. The delay time is the same as Panning Short.
- Mono Long:** The delayed sound is assigned to the center. The delay time is twice that of Panning L->R/R->L.

The delay time will differ depending on the delay type. When **Time** is turned fully towards the right, the delay time for each delay type will be as follows.

- Mono Long:** = 1250 ms (1.25 seconds)
- Panning L->R / R->L** = 625 ms
- Panning Short / Mono Short** = 156 ms

## ARPEGGIATOR

The arpeggiator is a function that breaks an incoming MIDI chord down into single notes and plays them rhythmically.

### On button

This button turns the arpeggiator on or off.

### Sync button

This button turns synchronization to the host tempo on or off.

### Tempo

Set the tempo of the arpeggiator with the tempo knob. The range is 8-256 bpm. If "Sync" is activated, the tempo can be set to the following note intervals: 1/32, 1/16d, 1/16, 1/8d, 1/8, 1/4d, 1/4

### Octave

Click the "Oct" link to change the number of octaves notes are played in one arpeggiator cycle. The range is 1-10 octaves.

### Mode

Click the "Mode" link to change the mode how incoming notes are played by the arpeggiator. The modes are Up, Down, Up&Down, Random



## REVERB

A Reverb is another addition the real JP-8080 did not have. A nice vintage Plate Reverb is always nice to have. It is a global reverb and is routed as a Post FX to all sounds produced by the synth layers. Settings of the Reverb are stored with the patches. It features a LPF and a HPF Filter.

### ON

This button turns the reverb on or off.

### ROOM

Turn this control to the right to make the roomsize of the reverb larger. Turn it to the left to make the roomsize smaller.

### PRE-DELAY

The Pre-Delay control influences the start phase of the reverb. Turning the control to the right increases the time in milliseconds, till the reverb effect starts to sound after a sound is played.

### DAMP

The damping control is an emulation of the natural falloff of high frequencies, if the room or hall is less reflective to sound in general. a hard and smooth reflective surface bounces back high frequencies much stronger, than a soft and rough surface. Turn the damping control to the right to increase the damping effect. Turn it to the left to decrease the damping effect.

### LOW (Low Pass Filter)

The control is the Frequency Cutoff for the LPF. Turn the control to the left to decrease the amount of high frequencies passing through. Turn it to the right to increase the amount of high frequencies passing through





## HIGH (High Pass Filter)

The control is the Frequency Cutoff for the HPF. Turn the control to the left to increase the amount of low frequencies passing through. Turn it to the right to decrease the amount of low frequencies passing through.

## MOD MATRIX

The JP-88ty has a Modulation Matrix. A total of 8 different modulation settings can be made. Every modulation setting can have a different mod source and a different target. It's also possible to have the same mod sources or targets for all 8 settings. Mod Matrix assignments are made for both Layers of the synth. It is not possible to route a Source to a Layer-specific Target.



### Source

Click on a source field to open the quick menu to select a source item. Select "Off" to deactivate a source.

### Amount

This value determines the amount of modulation. In center position the value is 0 and no modulation will happen to a target. Positive values increase a positive modulation to a target. Negative values increase a negative modulation to a target.

### Target

Click on a target field to open the quick menu to select a target item. Select "Off" to deactivate a target.

## MATRIX MENU

If the Mod Matrix is visible, press the hamburger icon to open the matrix menu.

### Reset all Sources

This option will only set all the Sources to Off

### Reset all Targets

This option will only set all the Targets to Off

### Reset all Amounts

This option will only set all the Amounts to 0.

### Reset All

This option will set any Sources and Targets to Off and the Amounts to 0.

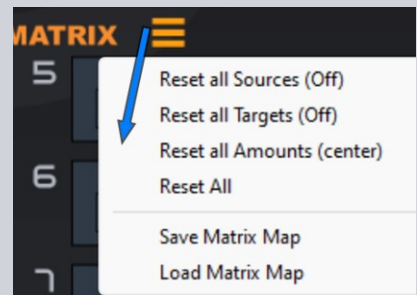

## KEY MODE - LAYER - VOLUME

The JP-88ty features two independent synthesizer Layers. The Layers are named **LOWER** and **UPPER**.

Each Layer features all the sections framed by an orange line like shown in the graphical overview below. **LOWER** and **UPPER** even have their own **Tone**, **FX** and **Delay** sections.

This way sounds can be very complex in **Dual Mode**, or doubled and pan them in the Stereo field to make very wide sounds with only slight differences in each Synth Layer.



### COPY / PASTE (Layer sections)

All sections of each layer have a Copy/Paste Icon in their upper right corner. This allows to copy settings made in this section, over the the same section of the other layer. This comes in handy if the settings of the other layer need to be exactly the same, or only needed to be changed a little bit.



## KEY MODE

Select the Key Mode of the Synthesizer Layers. If the selected Key Mode is **SINGLE**, the JP-88ty plays one Layer at a time depending on the LOWER or UPPER selection.

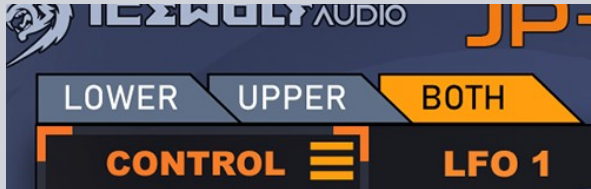

If the Key Mode is set to **DUAL**, the JP-88ty plays both layers simultaneously. In this Key Mode the **BOTH** selection comes into play. If **BOTH** is selected, every value change in the layer affects both layers at once. Values of the two layers can still be made individually. Select LOWER or UPPER to change values in the corresponding Layer.

In DUAL Mode the amount of available voices in the JP-88ty is shared to both layers. Max voices 18 means the synth has 9 voices available in Dual Mode. The amount of used and total available voices is shown in the main display.



## ADDITIONAL LAYER CONTROLS

### DETUNE

This control fine-tunes both levels to the opposite extent. Turning the knob from the center to the right adjusts the LOWER layer pitch up and the UPPER layer pitch down. Turning the knob from the center to the left will tune the LOWER layer pitch down and the UPPER layer pitch up. If **Key mode** is set to **SINGLE**, the Detune control has no effect on the pitch of the oscillators.

### SPREAD

This control affects the panning of both levels. It is a stereo widener control that is effective when used in DUAL key mode. The pan value is the same for both planes, but is positive for one of the planes and negative for the other. Rotating the knob from the center to the right moves the LOWER layer position to the right and the UPPER layer position to the left. Rotating the knob from the center to the left moves the LOWER layer position to the left and the UPPER layer position to the right. In **Key mode SINGLE**, the Spread control has no effect on any panning.

## VOLUME

This is the main **Volume** control for the JP-88ty. The value of this control is a global one and stored in the settings.cfg. Use this volume control to set your preferred overall volume for the JP-88ty. For individual volume settings of the patches and the layers, use the **Level** controls in the **Amp** sections.

## - final words -

The software is distributed as is. Any updates to the software released in the future will be available as free downloads to anyone.

I will not be able to take suggestions and new features into account for now. If new features are requested and i am getting aware of this requests, i may be able to implement or rework parts of the software to enhance it.

Have fun with my software instrument!

Icewolf

